

NM8L and NM8SL Series Residual Current Operated Circuit Breaker

1. Scope of application

NM8L or NM8SL residual current operated circuit breaker is made of NM8 or NM8S combined with residual current protection module, NM8L and NM8SL series residual current operated circuit breakers, mainly apply to the circuits with alternating current of 50Hz, rated voltage of 400V and rated current up to 630A. It is used to provide protection of persons against indirect contact. Meanwhile, it can also provide additional protection against fire and other hazards which may develop as a result of an earth fault of a lasting nature. Obviously, it can provide protection of installations against overloads, short-circuit currents and under-voltage. They are in accordance with the standards of IEC 60947-2.

2. Normal service and installation conditions



- 2.1 The altitude of the site of installation does not exceed 2000 m.
- 2.2 Foreign field of the installation site for residual current operated circuit breaker should not exceed five times of earth magnetic field in any direction.
- 2.3 Operating value of Electronic release will not be affected by temperature variation; however, the maximum permissible current of residual current operated circuit breaker is related to ambient temperature.

2.4 Humidity: Relative humidity of atmosphere doesn't exceed 50% at ambient temperature of +40°C. Higher relative humidity may be permitted at lower temperature, and average maximum relative humidity for the wettest month can reach 90%, at the same time, the average lowest temperature is +25°C, and condensation produced on the surface of products due to temperature change shall be taken into consideration.

2.5 Pollution degree: pollution degree of residual current operated circuit breaker is Grade III.

3. Main technical parameters and configuration

Table 1



Type	NM8L-100S	NM8L-250S	NM8L-630S
Appearance			
Number of poles	3P/4P	3P/4P	3P/4P
Rated current (A) I_n	16,20,25,32,40,50,63,80,100	100,125,160,180,200,225,250	250,315,350,400,500
Rated insulation voltage (V) U_i	750	750	750
Rated impulse withstand voltage (kV) U_{imp}	8	8	8
Rated operational voltage (V) U_e	400	400	400
Rated ultimate short-circuit breaking capacity (kA) I_{cu} AC50Hz 400V	50	50	70
Rated service short-circuit breaking capacity (kA) I_{cs} AC50Hz 400V	50	50	70
Rated residual making and breaking capacity $I_{\Delta m}$ is 25% I_{cu} .	12.5	12.5	17.5
Utilization category	A	A	A
Isolation function	●	●	●
Life expectancy With load/No load/Total	1500/85000/10000	1000/7000/8000	1000/4000/5000
Protection			
Types of release	Thermo-magnetic type	Thermo-magnetic type	Thermo-magnetic type
Overload protection	●	●	●
Short circuit protection	●	●	●
Earth-fault protection	●	●	●
Residual operating current (the fourth gear being adjustable) $I_{\Delta n}(A)$	X1: 0.05/0.1/0.2/0.5; X2: 0.1/0.3/0.5/1	X1: 0.05/0.1/0.2/0.5; X2: 0.1/0.3/0.5/1	X2: 0.1/0.3/0.5/1
Break-time (the fourth gear being adjustable) Total break-time (s)	t1: 0.3/0.5/1	t1: 0.3/0.5/1	t1: 0.3/0.5/1
Installation and connection			
Fixed/front connection plate(internal)	●	●	●
Fixed/rear connection plate (internal)	■	■	■
Indicating auxiliary devices (auxiliary switch)	■	■	■
Control auxiliary devices			
Motor operating mechanism	■	■	■
Standard rotary operating handles	■	■	■
Extended rotary operating handles	■	■	■
Installation and connection accessories			
Cage clamp terminals	■	■	■
DIN rail adapter	■	■	—
Terminal shield	■	■	■
Inter-phase isolation board	●	●	●
Dimension L x H x D(mm) 3P/4P	90×205×103/120×205×103	105×232×126/140×232×126	140×355×168/185×355×168
3P/4P Weight (Kg)	2/3.5	2.6/4	9.5/11.5

* with ■ inside table 1 means you can configure ; ● means standard configuration.

* Accessories can be used interchangeably with NM8 series MCCB.



Table 2

Type	NM8SL-100S	NM8SL-250S	NM8SL-630S
Appearance			
Number of poles	3P/4P	3P/4P	3P/4P
Rated current (A) I_n	40,50,63,80,100	125,160,180,200,225,250	250,315,350,400,500,630
Rated insulation voltage (V) U_i	750	750	750
Rated impulse withstand voltage (kV) U_{imp}	8	8	8
Rated operational voltage (V) U_e	400	400	400
Rated ultimate short-circuit breaking capacity (kA) I_{cu} AC50Hz 400V	50	50	70
Rated service short-circuit breaking capacity (kA) I_{cs} AC50Hz 400V	50	50	70
Rated residual making and breaking capacity $I_{\Delta m}$ is 25% I_{cu} .	12.5	12.5	17.5
Utilization category	A	A	A
Isolation function	●	●	●
Life expectancy with load No-load Amount	1500/8500/10000	1000/7000/8000	1000/4000/5000
Protection			
Types of release	Electronic type	Electronic type	Electronic type
Overload protection	●	●	●
Short circuit protection	●	●	●
Earth-fault protection	●	●	●
Residual operating current (the fourth gear being adjustable) $I_{\Delta n}$ (A)	X1: 0.05/0.1/0.2/0.5; X2: 0.1/0.3/0.5/1	X1: 0.05/0.1/0.2/0.5; X2: 0.1/0.3/0.5/1	X2: 0.1/0.3/0.5/1
Break-time (the fourth gear being adjustable) Total break-time (s)	t1: 0.3/0.5/1	t1: 0.3/0.5/1	t1: 0.3/0.5/1
Installation and connection			
Fixed/front connection plate(internal)	■	■	■
Fixed/rear connection plate (internal)	■	■	■
Indicating auxiliary devices (auxiliary switch)	■	■	■
Control auxiliary devices			
Motor operating mechanism	■	■	■
Standard rotary operating handles	■	■	■
Extended rotary operating handles	■	■	■
Installation and connection accessories			
Cage clamp terminals	■	■	■
DIN rail adapter	■	■	—
Terminal shield	■	■	■
Inter-phase isolation board	●	●	●
Dimension L x H x D(mm) 3P/4P	105×232×126/140×232×126	105×232×126/140×232×126	140×355×168/185×355×168
3P/4P Weight (Kg)	2.6/4	2.6/4	10.5/12.5

* with ■ inside table 2 means you can configure ; ● means standard configuration.

* Accessories can be used interchangeably with NM8 series MCCB.

4. Others

4.1 Features

- 4.1.1 Adopt modular design, and users can install and maintain it by themselves, which will not affect characteristics of circuit breaker.
- 4.1.2 With power indicating function;
- 4.1.3 Residual operated current and residual current break-time is adjustable, which is convenience for users' selecting.
- 4.1.4 They have residual current operated indicating button and reset button, thus users can quickly judge the operation reasons of residual current operating circuit breaker. What's more, users cannot close residual current operating circuit breaker before they remove current leakage fault (not pressing reset button).
- 4.1.5 When residual current operated circuit breaker provided with auxiliary contact, It can provide remote indication function when there is current leakage fault.
- 4.1.6 High breaking capacity without arcover;
- 4.2 Being provided with isolation function and reliable contact indication
- 4.2.1 Isolation position is located at the location of "0"(OFF).
- 4.2.2 Only by completely opening of contact can operating handle indicate the position of "0"(OFF)
- 4.2.3 Users can install padlock only in opening status;
- 4.2.4 Rotary handles will not change the reliability of contact indication;
- 4.2.5 Isolation function should guarantee the reliability of contact indication mechanism, no residual current, and the source side terminal should withstand higher impulse voltage.
- 4.2.6 Symbol for isolation function

5. Configurations and Installation Dimension

5.1 Configuration and Dimension

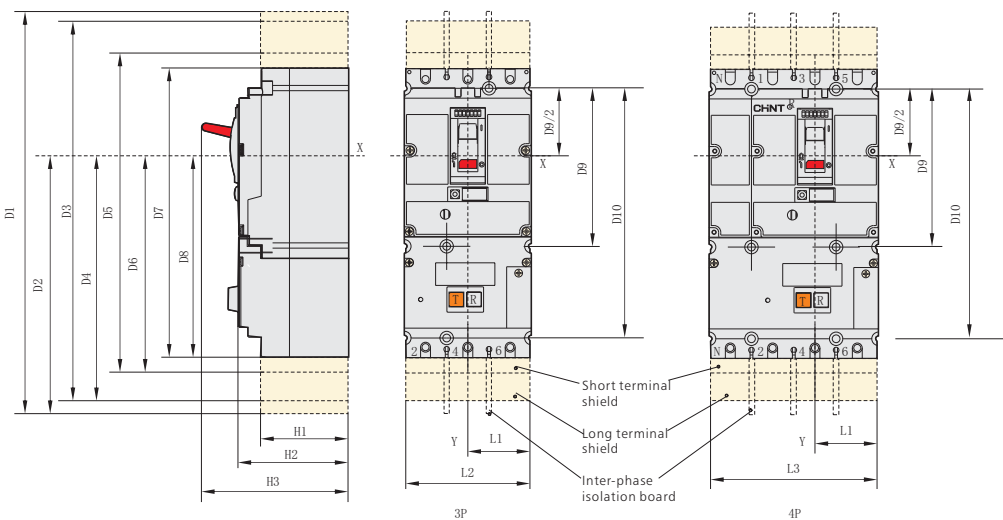

Type	Overall dimension															
	D1	D2	D3	D4	D5	D6	D7	D8	D9	H1	H2	H3	L1	L2	L3	D10
NM8L-100	305	185	270	167.5	225	145	205	135	112	63	79	103	45	90	120	177
NM8SL-100 NM8(S)L-250	432	253.5	396	235.5	263	169	232	153.5	125	73	89	126	52.5	105	140	200
NM8(S)L-630	574	337	580	340	385	242.5	355	227.5	200	95	113	168	70	140	185	300

5.2 Connection Dimension (See Figure)

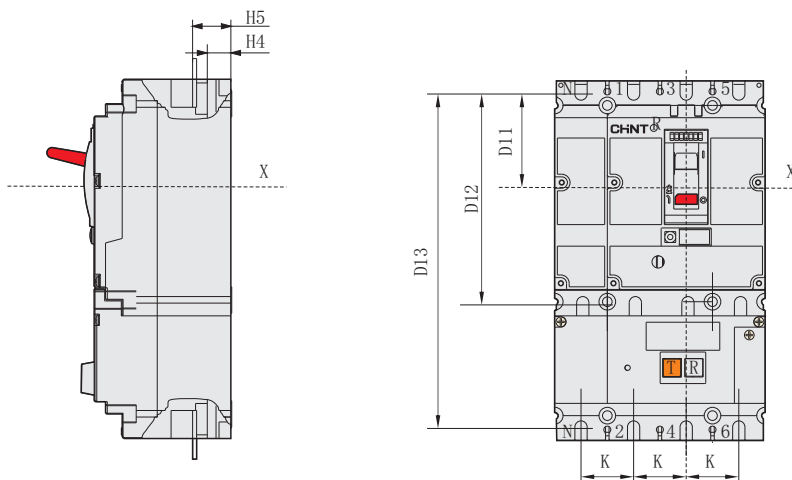

Type	Connection Dimension					
	D11	D12	D13	H4	H5	K
NM8L-100	63	126	191	19	225	30
NM8SL-100 NM8(S)L-250	70	140	215	21.5	263	35
NM8(S)L-630	113.5	227	327	26	44	45

5.3 Mounting Dimension

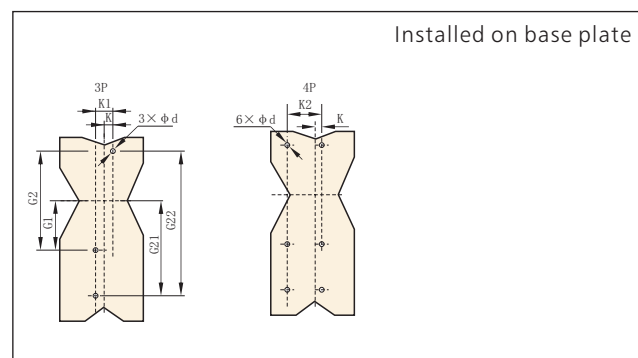
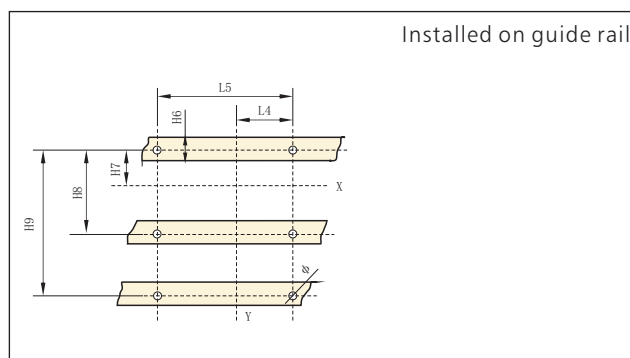

Type	Mounting dimension						
	L4	L5(3P/4P)	H6	H7	H8	H9	ϕ
NM8L-100	15	30/60	≤ 32	56	112	177	6
NM8SL-100 NM8(S)L-250	17.5	35/70	≤ 32	62.5	125	200	6
NM8(S)L-630	22.5	45/90	≤ 32	100	200	300	6.5

Type	Mounting dimension							
	K	K1	K2	G1	G2	G21	G22	d
NM8L-100	15	30	60	56	112	121	177	6
NM8SL-100 NM8(S)L-250	17.5	35	70	62.5	125	137.5	200	6
NM8(S)L-630	22.5	45	90	100	200	200	300	6.5

5.4 Front panel cut out
 Fixed or plug-in residual current protection circuit breakers

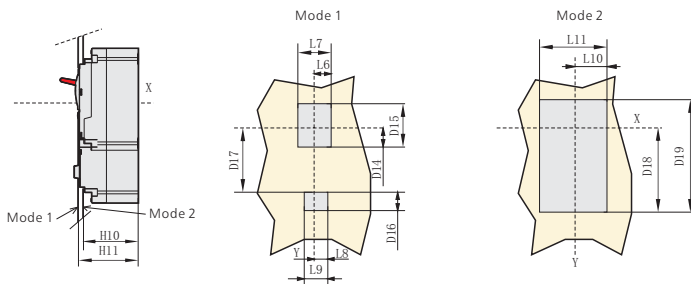

Type	Dimension of front panel cut out													
	D14	D15	D16	D17	D18	D19	H10	H11	L6	L7	L8	L9	L10	L11(3P/4P)
NM8L-100	26	68	20	84	115	165	73	80	13	26	13	26	46.5	93/123
NM8SL-100、NM8(S)L-250	33	78	20	96	132	188	83	90	14.5	29	14.5	29	54	108/143
NM8(S)L-630	41.5	116	29	146.5	202	294	109	114	26.5	53	24	48	71.5	143/188

5.5 Connection

Dimension of connecting screws:

- NM8L-100: M6
- NM8SL-100、NM8SL-250、NM8L-250: M8
- NM8(S)L-630: M10

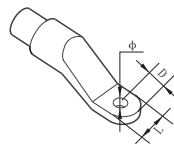

Copper cable connection strap

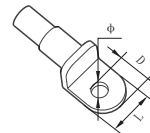

Aluminum cable connection strap

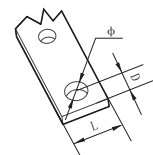

Copper bar

	NM8L-100	NM8(S)L-250 NM8SL-100	NM8(S)L-630
Pole distance (mm)	30	35	45
L(mm)	≤15	≤25	≤32
D(mm)	≤7	≤10	≤16
φ (mm)	>6	>8	>10

6. Ordering information

To be Indicated by Users While Ordering:

Name and type, rated current, rated residual operating current, break- time, types of protection, number of poles and quantity of residual current operated circuit breakers , and types and rated value of internal and external accessories . For example, ordering NM8L thermo-magnetic frame size rated current of 250A, standard type breaking capacity, 4 poles and N-pole with protection, on-off with the other three poles; motor protection type, rated residual operating current (A): 0.1~0.3~0.5~1; rated residual current break-time time (s) : 0.1~0.3~0.5~1;equipped with rotary handle, and 100 sets of residual current operated circuit breakers provided with AC220V under voltage releases and auxiliary contact.

Order code of residual current operated circuit breakers: NM8L-250S/250/4C/M, RCD24, 100 sets.

Order code of residual current operated circuit breakers with accessories: NM8L-250S/BM23 100 sets/RH22 100 sets/UM5 100 sets/AX 100 sets

Quick selection table for NM8(S) L series residual current operated circuit breakers

Quick selection table for NM8(S)L series residual current operated circuit breaker

Feature code of breaking capacity	Number of poles	Usage
S: Standard	3 means 3 poles 4 means 4 poles 4A : Without current release components, N-pole is always at making status; 4B : Without current release components, N-pole make with other three poles (N-pole first makes then breaks). 4C : With current release components, N-pole makes and breaks with other three poles ,N-pole first makes then breaks; N-pole operating current is 1.0In. 4D With current release components, N-pole is always at making status; operating current is 1.0In;	M: Motor protection No code: Power distribution protection

NM8L - 250 S / 250 / 4C / M RCD24

Product type and release type	Frame size	Rated current (A)	Rated residual operating current, Combined type of break time
NM8L: Thermo-magnetic type Residual current operating circuit breakers	100A	16,20	NM8L-100 3P RCD11 RCD12
	250A	32,40	4P RCD13 RCD14
NM8SL: Electronic type Residual current operating circuit breakers	630A	50,63	NM8L-250 3P RCD21 RCD22
		80,100	NM8SL-250,100 4P RCD23 RCD24
		125,160	
		180,200	
		225,250	
	315,350		
	400,500		
	630		NM8(S)L-630 3P RCD31
			4P RCD32
Remark: Rated residual operating current (A) X1: 0.05~0.1~0.2~0.5 X2: 0.3~0.5~1 Break- time(s) of rated residual operating current t1: 0.1~0.3~0.5~1 RCD11、RCD13、RCD21、RCD23: X1, t1 RCD12、RCD14、RCD24、RCD31、RCD32: X2, t1			
Note: for thermo-magnetic type, the rated operational current is up to 500A			

**Quick selection table for accessories of NM8(S) L series
residual current operated circuit breakers**

NM8L-250S / BM23 / RH22 / UM5 / AX

Connection mode	Control mechanism	Type of internal accessories			
FM13,FM14: front connection plate (NM8L-100) FM23,FM24: front connection plate(NM8(S)L-250,NM8SL-100) FM33,FM34: front connection plate (NM8(S)L-630) BM13,BM14: Rear connection plate (NM8L-100) BM23,BM24: Rear connection plate(NM8(S)L-250,NM8SL-100) BM33,BM34: Rear connection plate (NM8(S)L-630) DIN13,DIN14:DIN Rail adaptor (NM8L-100) DIN23,DIN24:DIN Rail adaptor (NM8(S)L-250,NM8SL-100) CT13,CT14: Cage connection terminal (NM8L-100) CT23,CT24: Cage connection terminal (NM8(S)L-250,NM8SL-100) CT33,CT34: Cage connection terminal (NM8(S)L-630) LT13,LT14: Extended terminal shield (NM8L-100) LT23,LT24: Extended terminal shield (NM8(S)L-250,NM8SL-100) LT33,LT23: Extended terminal shield (NM8(S)L-630) ST13,ST14:Short terminal shiel (NM8L-100) ST23,ST24:Short terminal shiel (NM8(S)L-250,NM8SL-100) ST33,ST23:Short terminal shiel (NM8(S)L-630)	RH11,RH14:Economical extended rotary handle (NM8L-100) RH21,RH24:Economical extended rotary handle (NM8(S)L-250,NM8SL-100) Rh31:Economical extended rotary handle (NM8(S)L-630) Rh12:Standard rotary handle (NM8L-100) Rh22:Standard rotary handle (NM8(S)L-250,NM8SL-100) Rh32:Standard rotary handle (NM8(S)L-630) Rh13:extended rotary handle (NM8L-100) Rh23:extended rotary handle (NM8(S)L-250,NM8SL-100) Rh33:extended rotary handle (NM8(S)L-630) M012,M013:Electric operating mechanism (NM8L-100) M022,M023:Electric operating mechanism (NM8(S)L-250,NM8SL-100) M032,M033:Electric operating mechanism (NM8(S)L-630) Pd1:Locking system (NM8L-100) Pd2:Locking system (NM8(S)L-250,NM8SL-100) Pd3:Locking system (NM8(S)L-630)	Shunt release SM6: AC220V/230V SQ6: AC380V/400V (NM8L-100) SM5: AC220V/230V SQ5: AC380V/400V (NM8(S)L-250,630)	Under- voltage release UM6: AC220V/230V UQ6: AC380V/400V (NM8L-100) UM5: AC220V/230V UQ5: AC380V/400V (NM8(S)L-250,630);	Auxiliary contact AX Used for the whole series	Alarm system AL Used for the whole series

Note: 1. Please contact the sales department or technical department when your requirements are beyond the specification or sample technical requirements, which will be treated as a special order.
 2. Selection, installation and application should be in accordance with instructions of the products or requirements of relevant national standards.